

WICTEC 50EH

Stijl-regel-gevel
Inbraakwerend volgens DIN V ENV 1627
Inbraakwerendheidsklasse 2 (WK2)

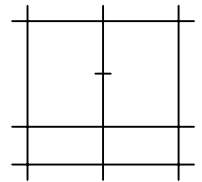

Doorsnede stijl

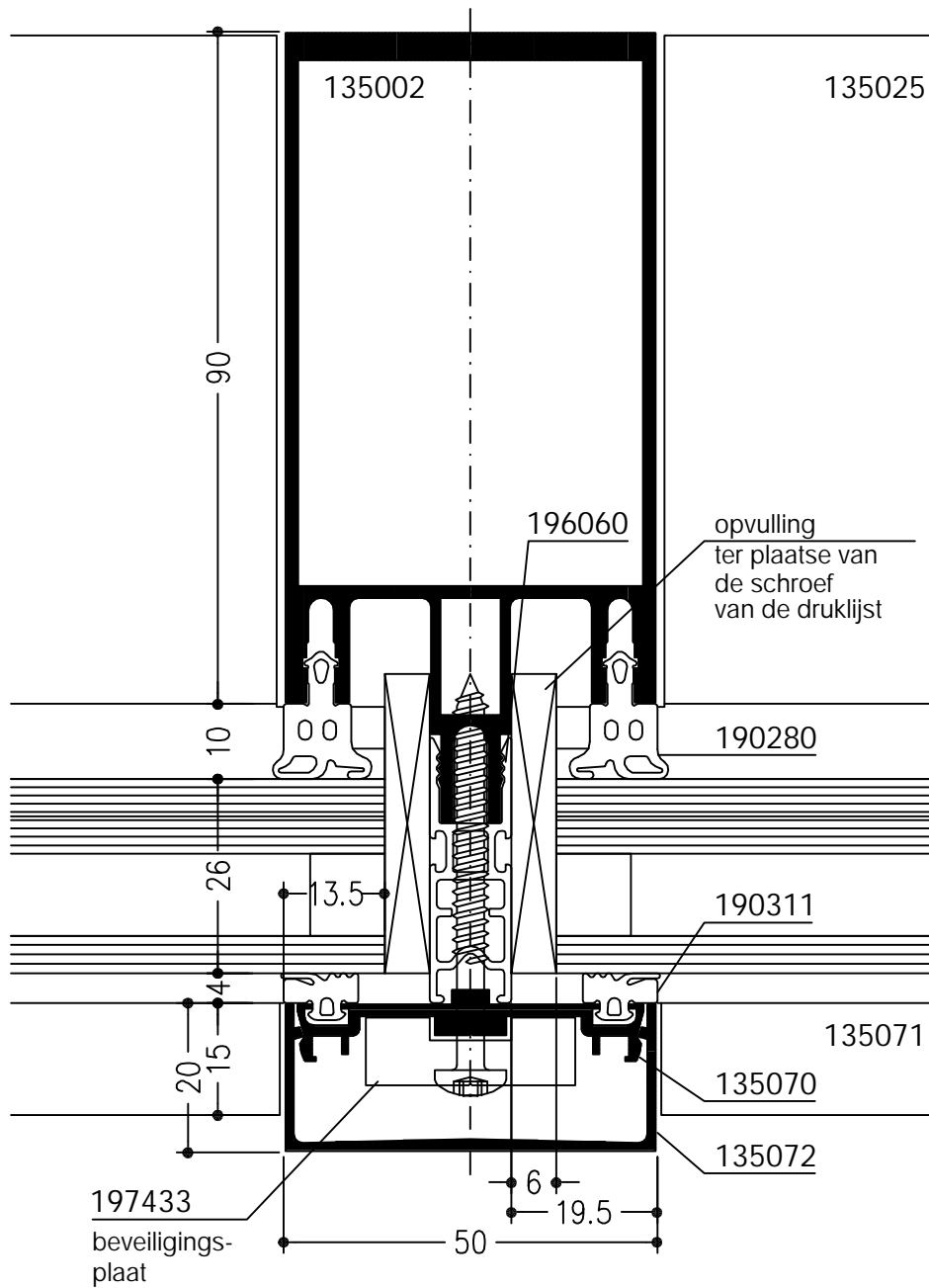

WICTEC 50EH

Stijl-regel-gevel
Inbraakwerend volgens DIN V ENV 1627
Inbraakwerendheidsklasse 2 (WK2)

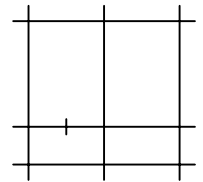

Doorsnede regel

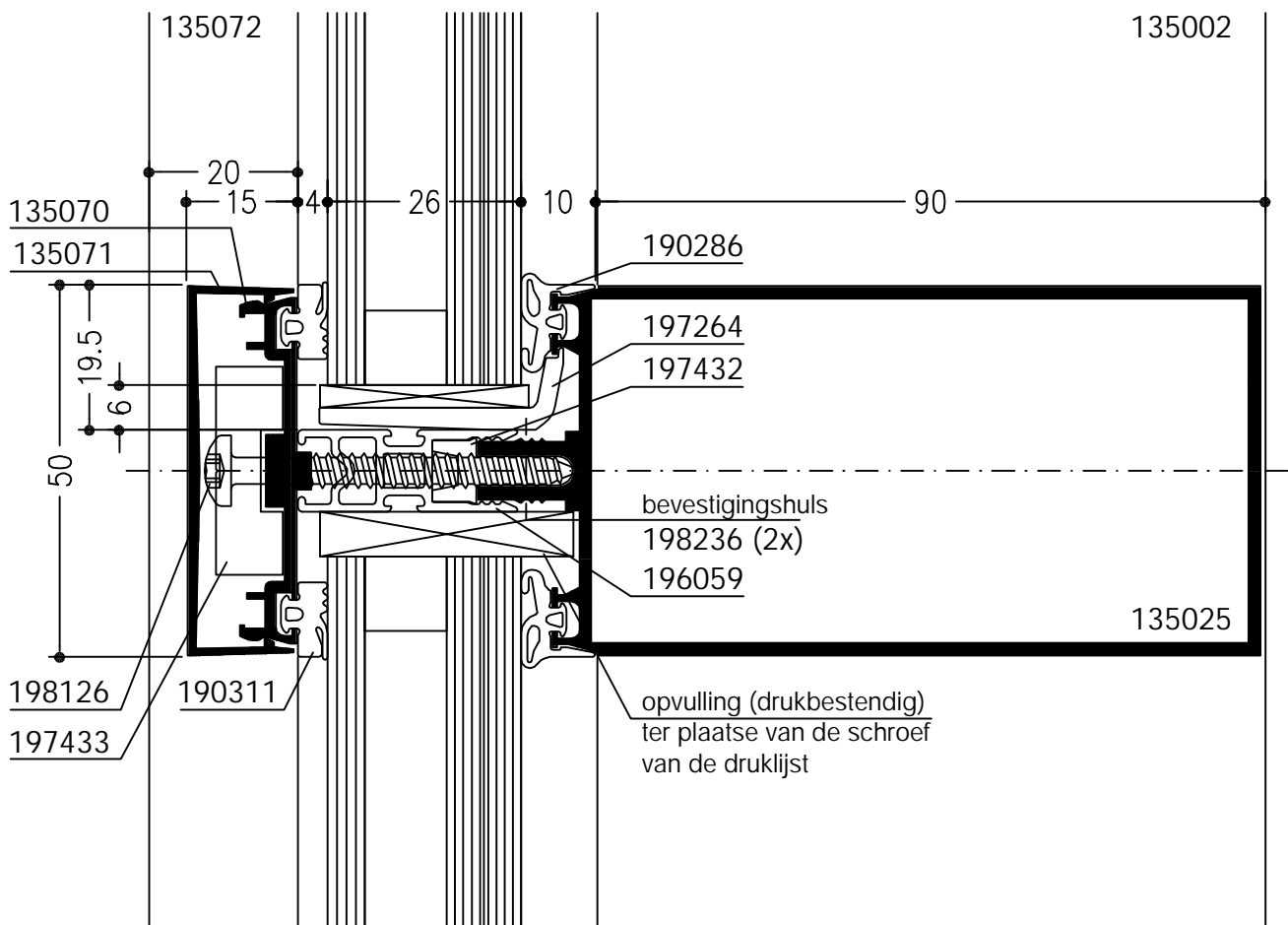

WICTEC 50EH

Stijl-regel-gevel
Inbraakwerend volgens DIN V ENV 1627
Inbraakwerendheidsklasse 2 (WK2)

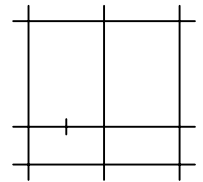

Doorsnede regel
inbouw glassteun

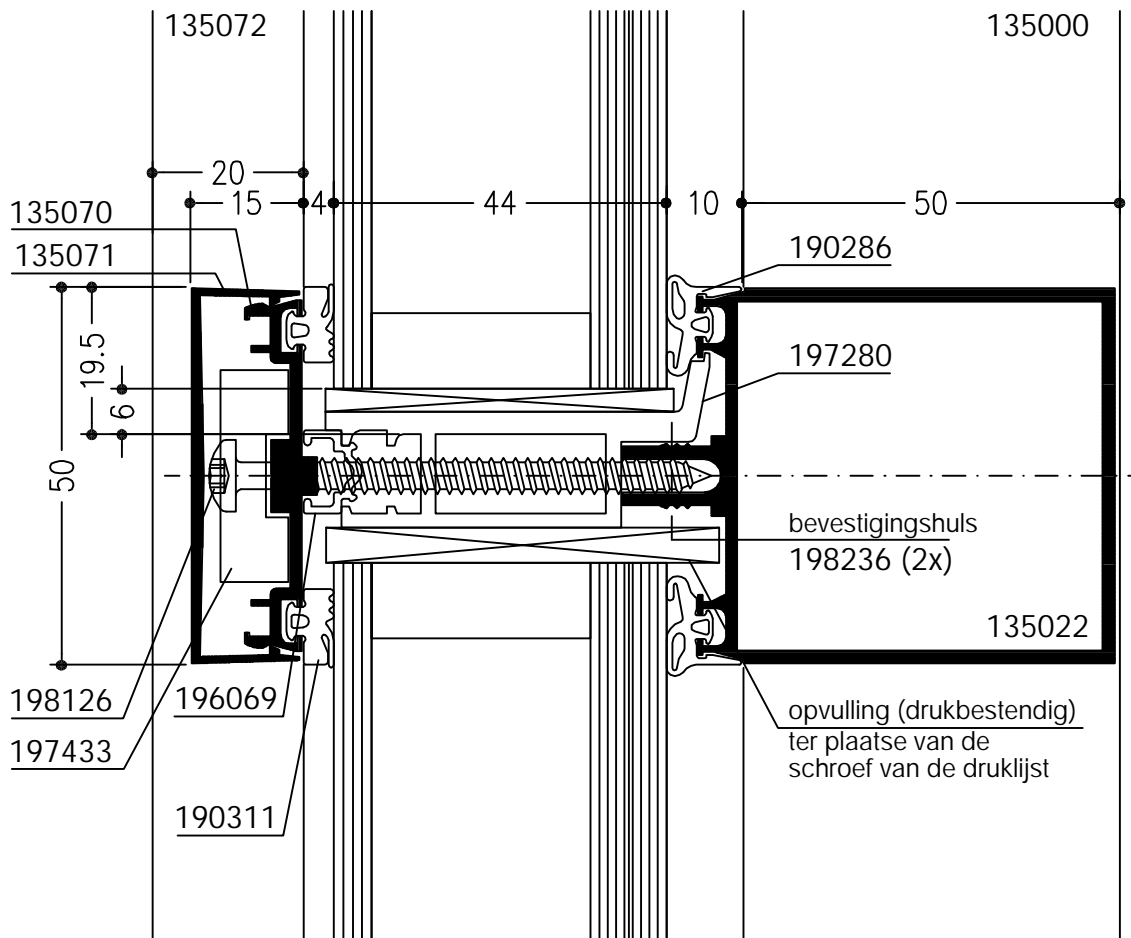

WICTEC 50EH

Stijl-regel-gevel
Inbraakwerend volgens DIN V ENV 1627
Inbraakwerendheidsklasse 3 (WK 3)

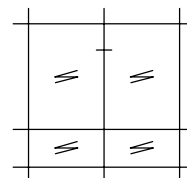

Enkele beglazing

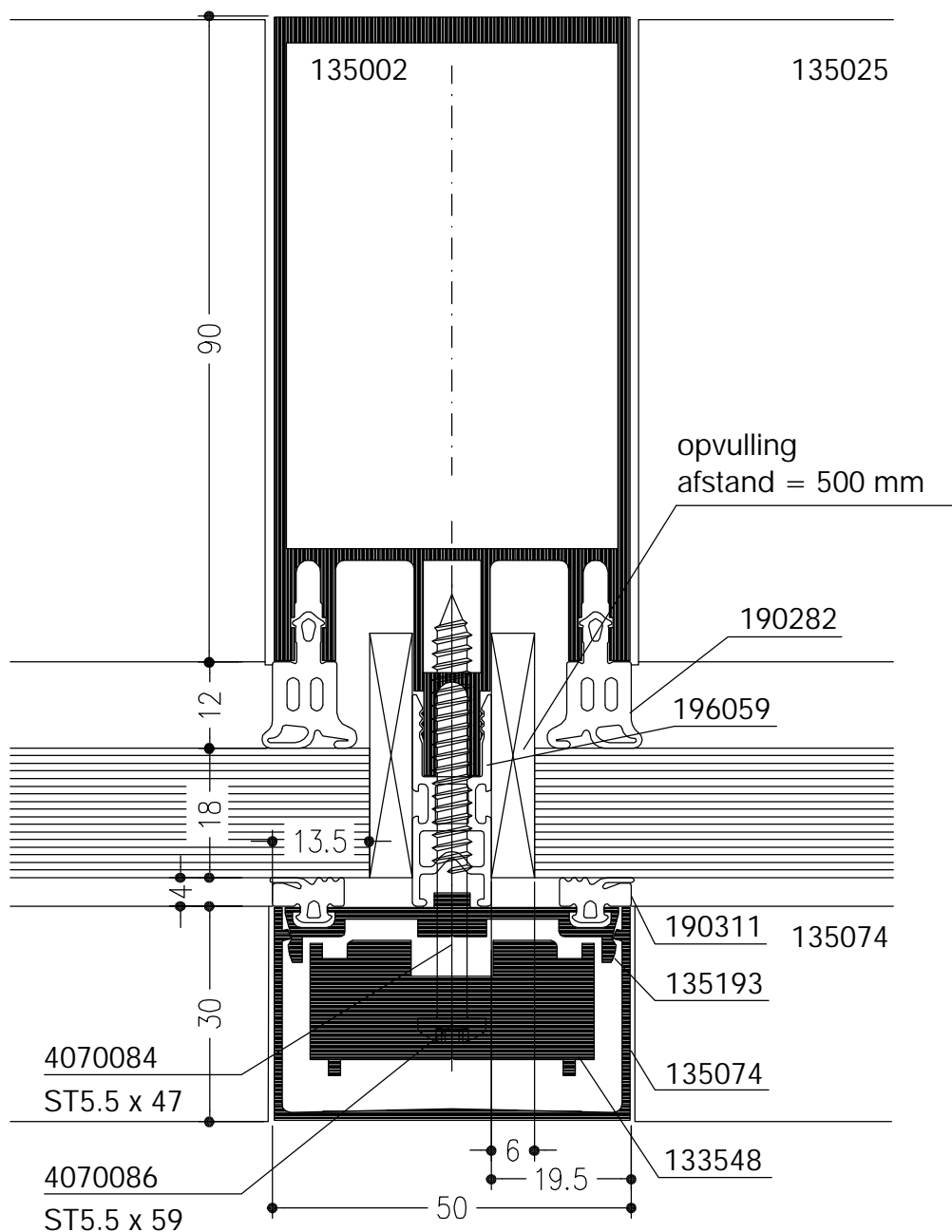

Horizontale doorsnede
stijl E1 met enkele beglazing P6B

WICTEC 50EH

Stijl-regel-gevel

Inbraakwerend volgens DIN V ENV 1627

Inbraakwerendheidsklasse 3 (WK 3)

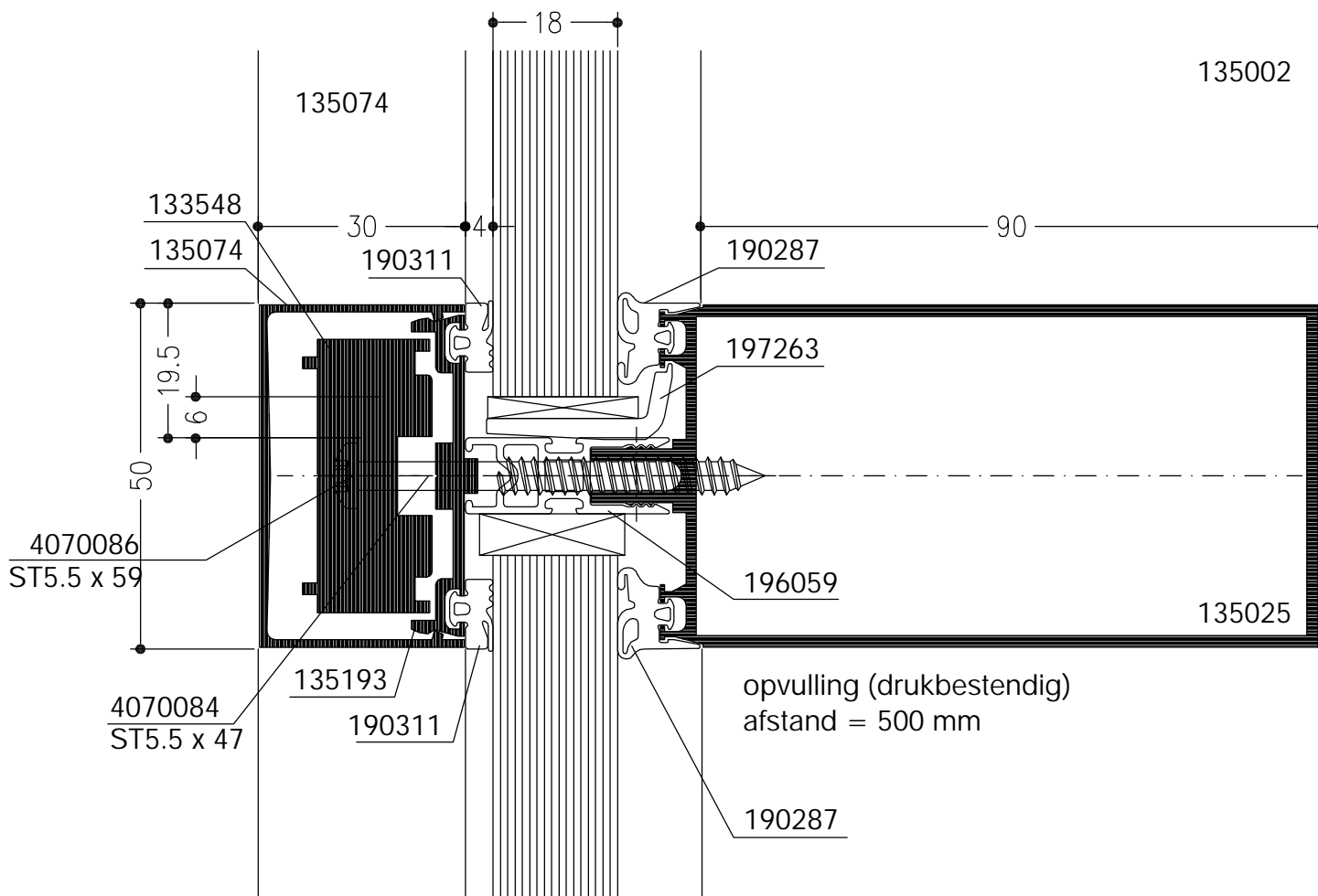
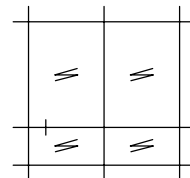

Verticale doorsnede
regel E2 met enkele beglazing P6B

WICTEC 50EH

Stijl-regel-gevel

Inbraakwerend volgens DIN V ENV 1627

Inbraakwerendheidsklasse 3 (WK 3)

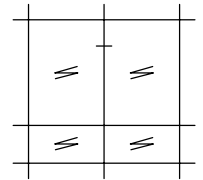

Geïsoleerde beglazing

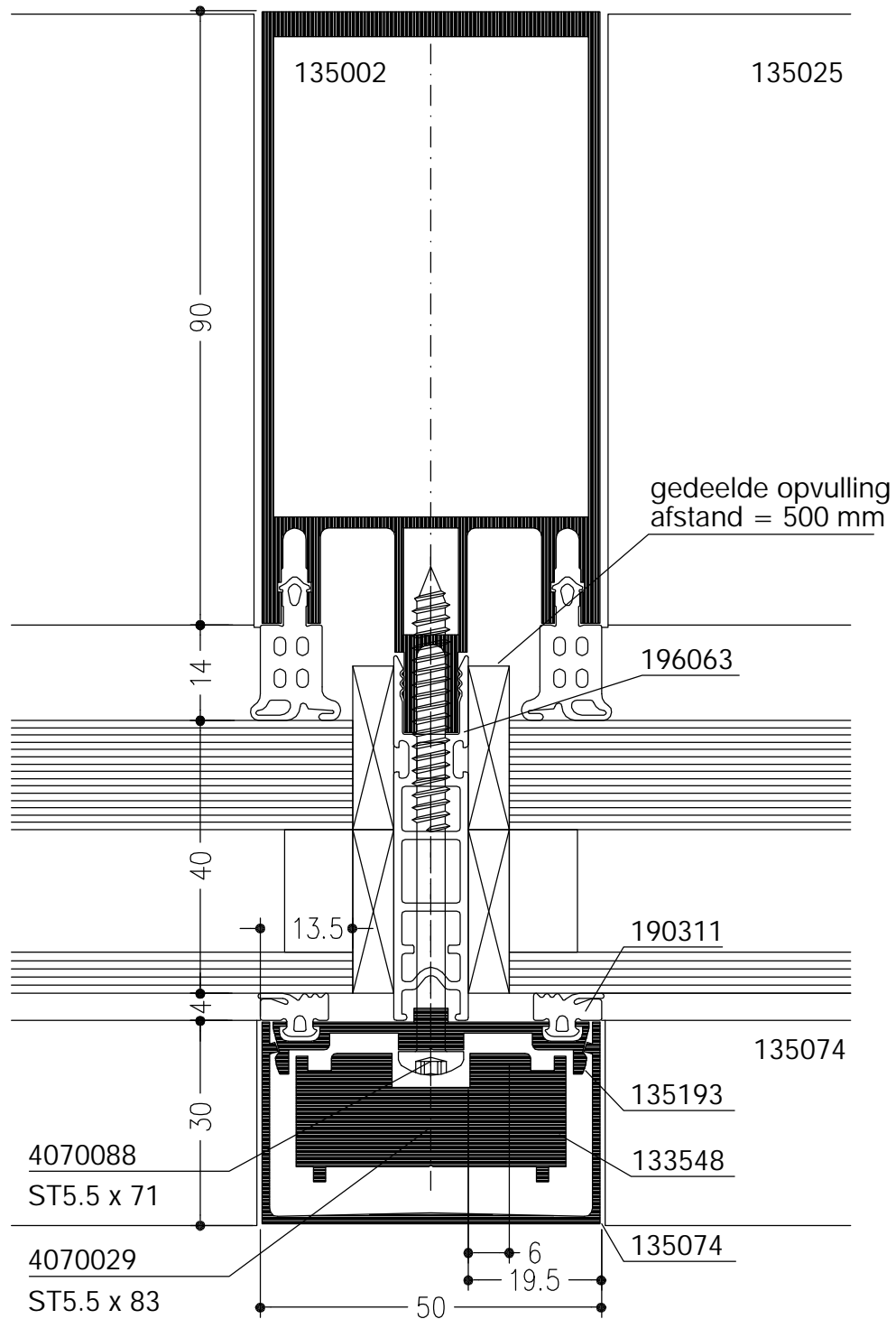

Horizontale doorsnede
stijl E1 met vaste beglazing P6B

WICTEC 50EH

Stijl-regel-gevel

Inbraakwerend volgens DIN V ENV 1627

Inbraakwerendheidsklasse 3 (WK 3)

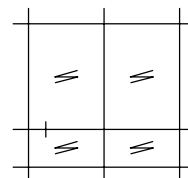

Geïsoleerde beglazing

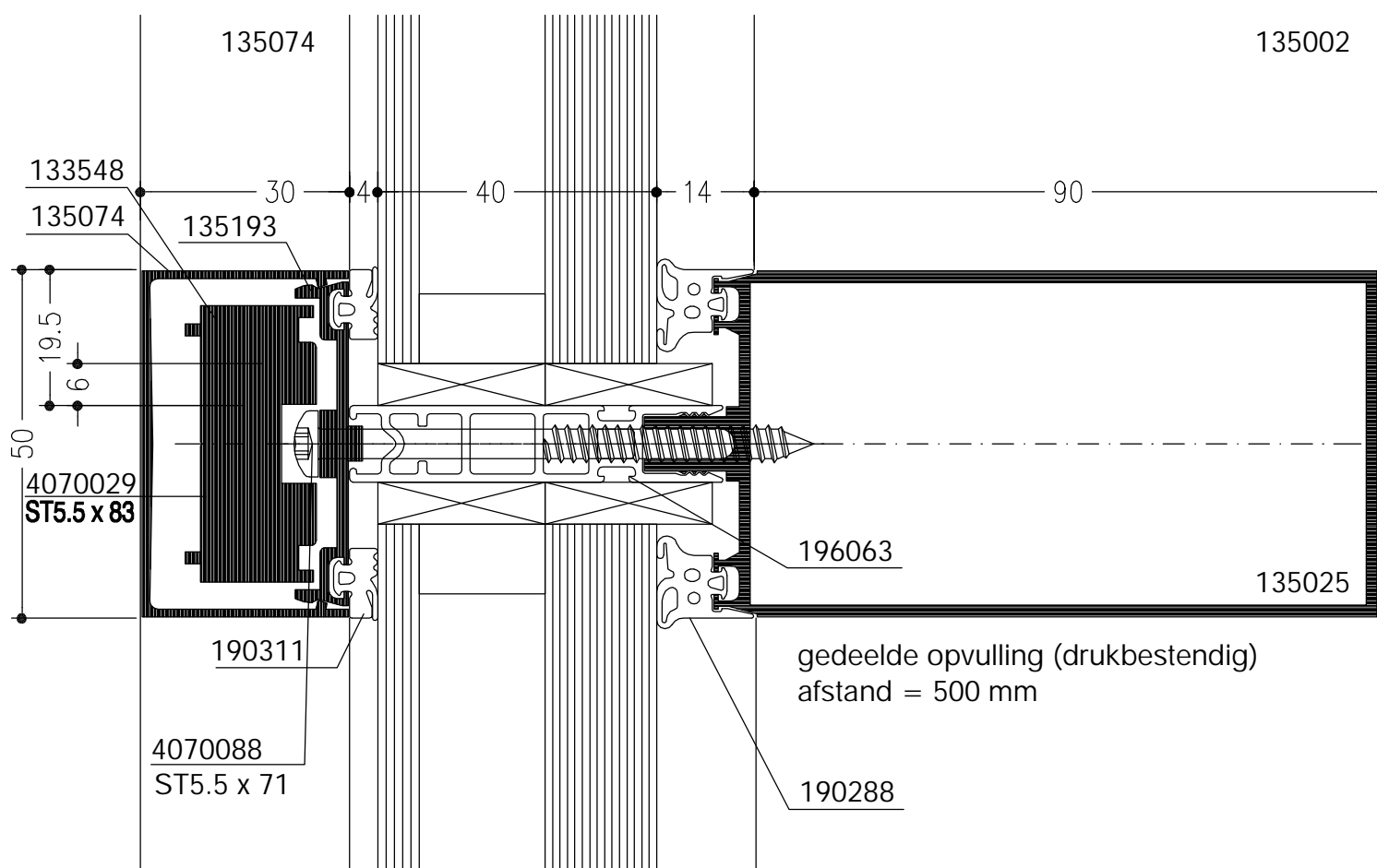

Verticale doorsnede
regel E2 met vaste beglazing P6B

WICTEC 50EH

Profieloverzicht

Stijl-regel-gevel

Inbraakwerend volgens DIN V ENV 1627

Inbraakwerendheidsklasse 2 (WK2)

Stijlen E1

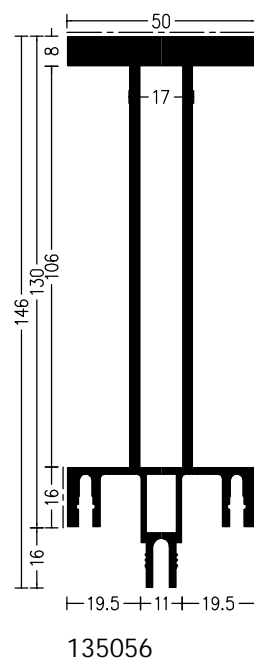
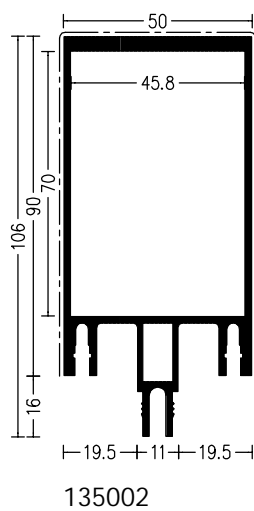
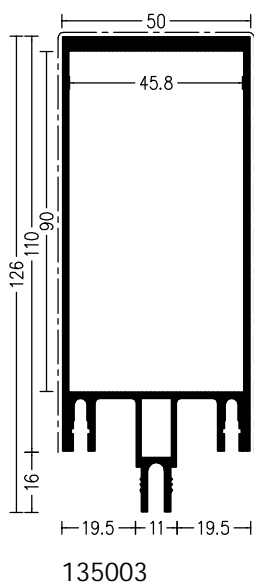
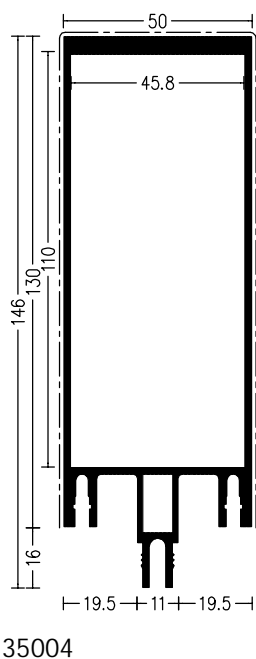
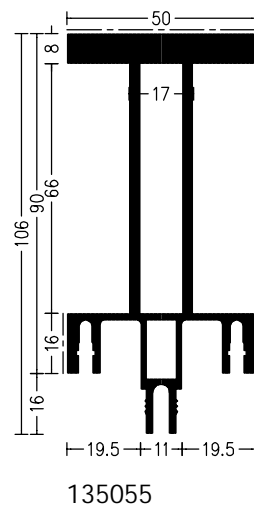
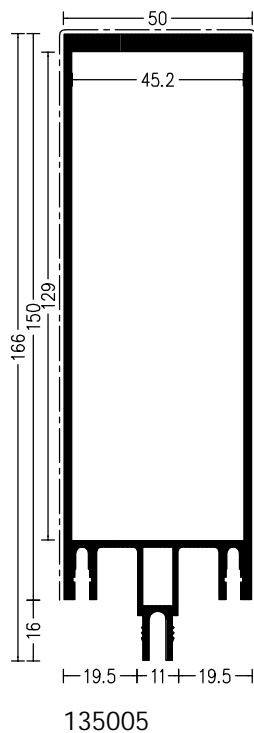
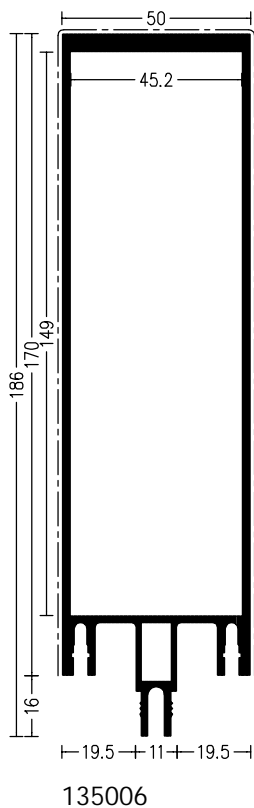
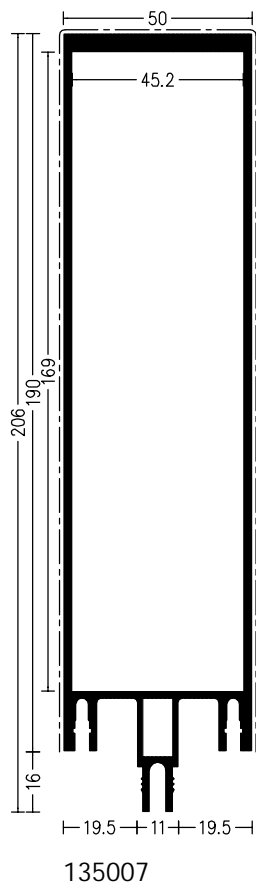

WICTEC 50EH

Profieloverzicht

Stijl-regel-gevel

Inbraakwerend volgens DIN V ENV 1627

Inbraakwerendheidsklasse 2 (WK2)

Regels E2

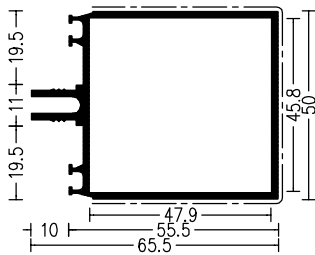

135023

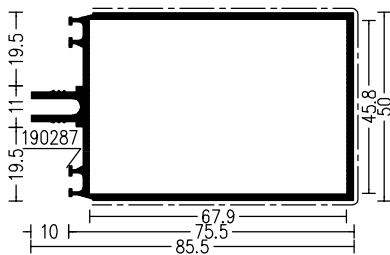

135024

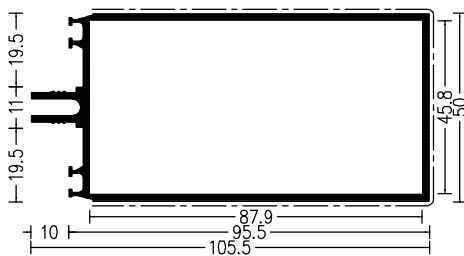

135025

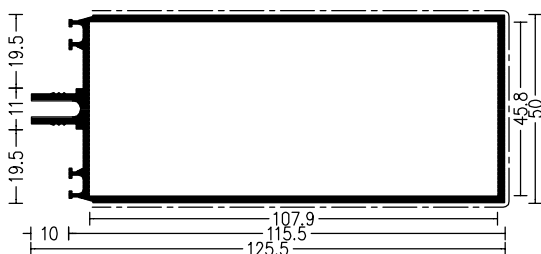

135026

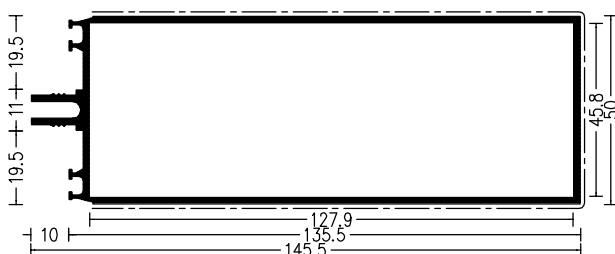

135027

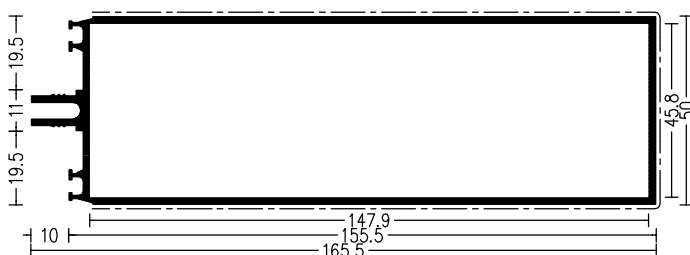

135028

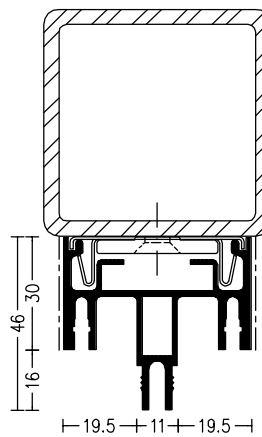

135061

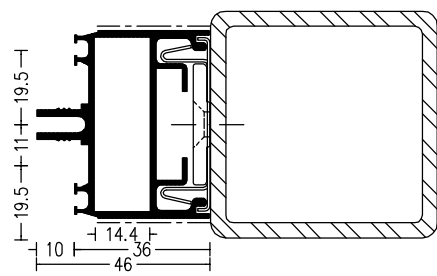

135063

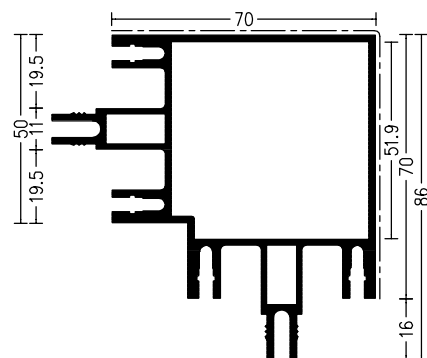

135018

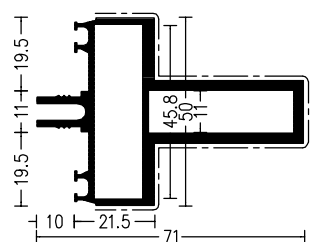

135057

WICTEC 50EH

Profieloverzicht

Stijl-regel-gevel
Inbraakwerend volgens DIN V ENV 1627
Inbraakwerendheidsklasse 2 (WK2)

Druklijsten en afdekprofielen

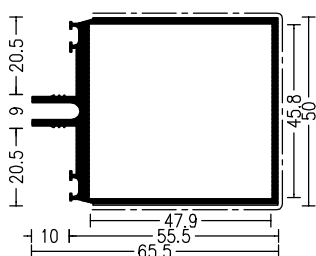
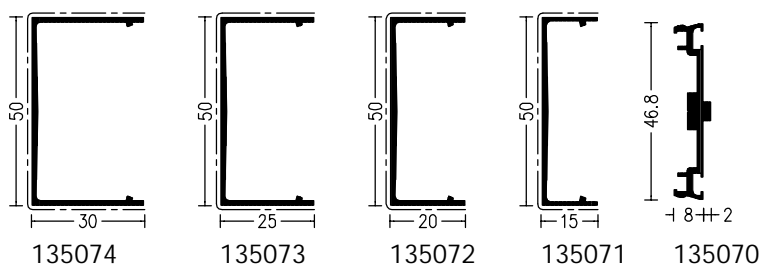

135032

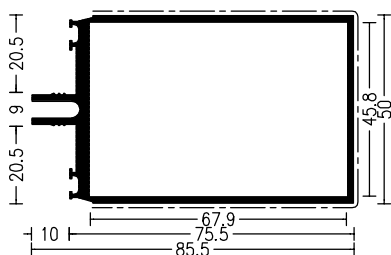

135033

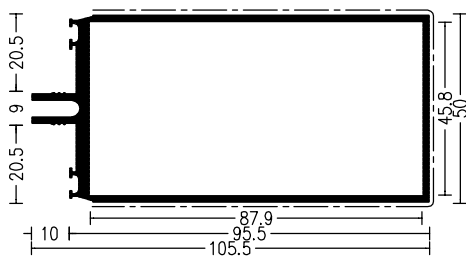

135034

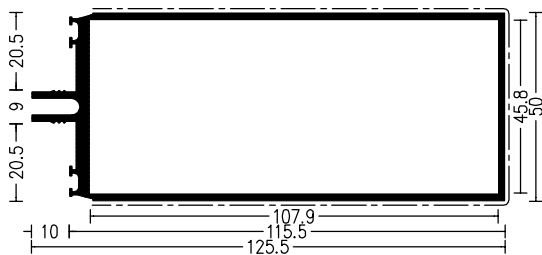

135035

Druklijsten en afdekprofielen

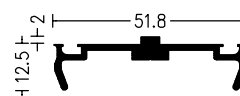

135069

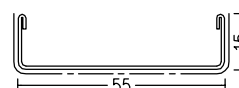

927604
RVS

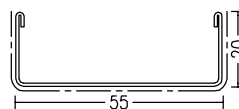

927614
RVS

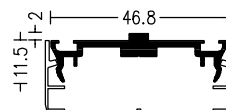

135075
voor object-afdekprofielen

WICTEC 50DH

Stijl-regel-gevel
Kogelwerend volgens DIN EN 1522
Weerstandsklasse FB4

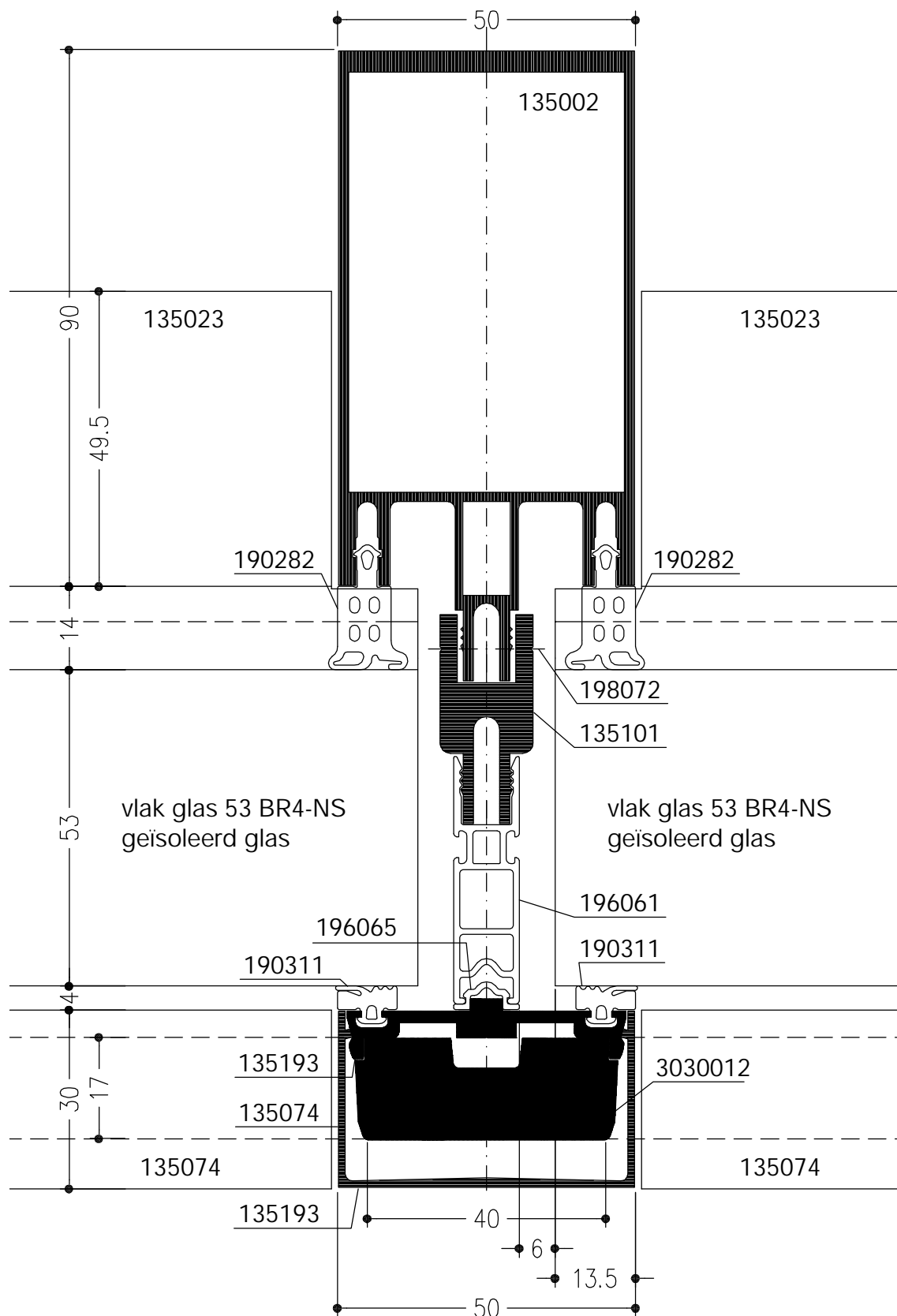
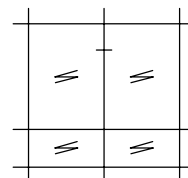

Horizontale doorsnede
stijl E1 met vaste beglazing BR4-NS

WICTEC 50DH

Stijl-regel-gevel
Kogelwerend volgens DIN EN 1522
Weerstandsklasse FB4

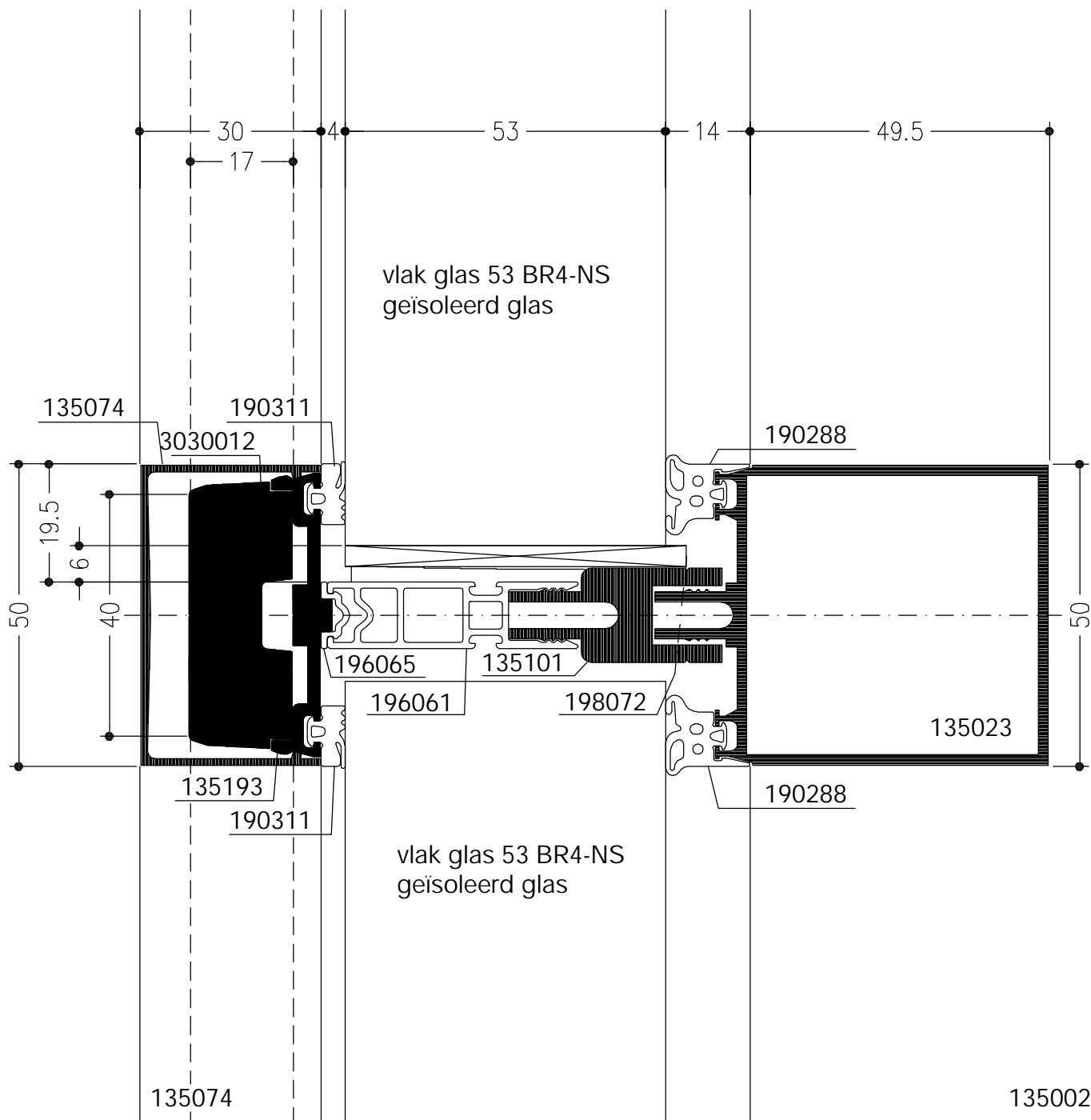
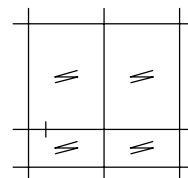

Verticale doorsnede
regel E2 met vaste beglazing BR4-NS

WICTEC 50DH

Stijl-regel-gevel
Kogelwerend volgens DIN EN 1522
Weerstandsklasse FB4

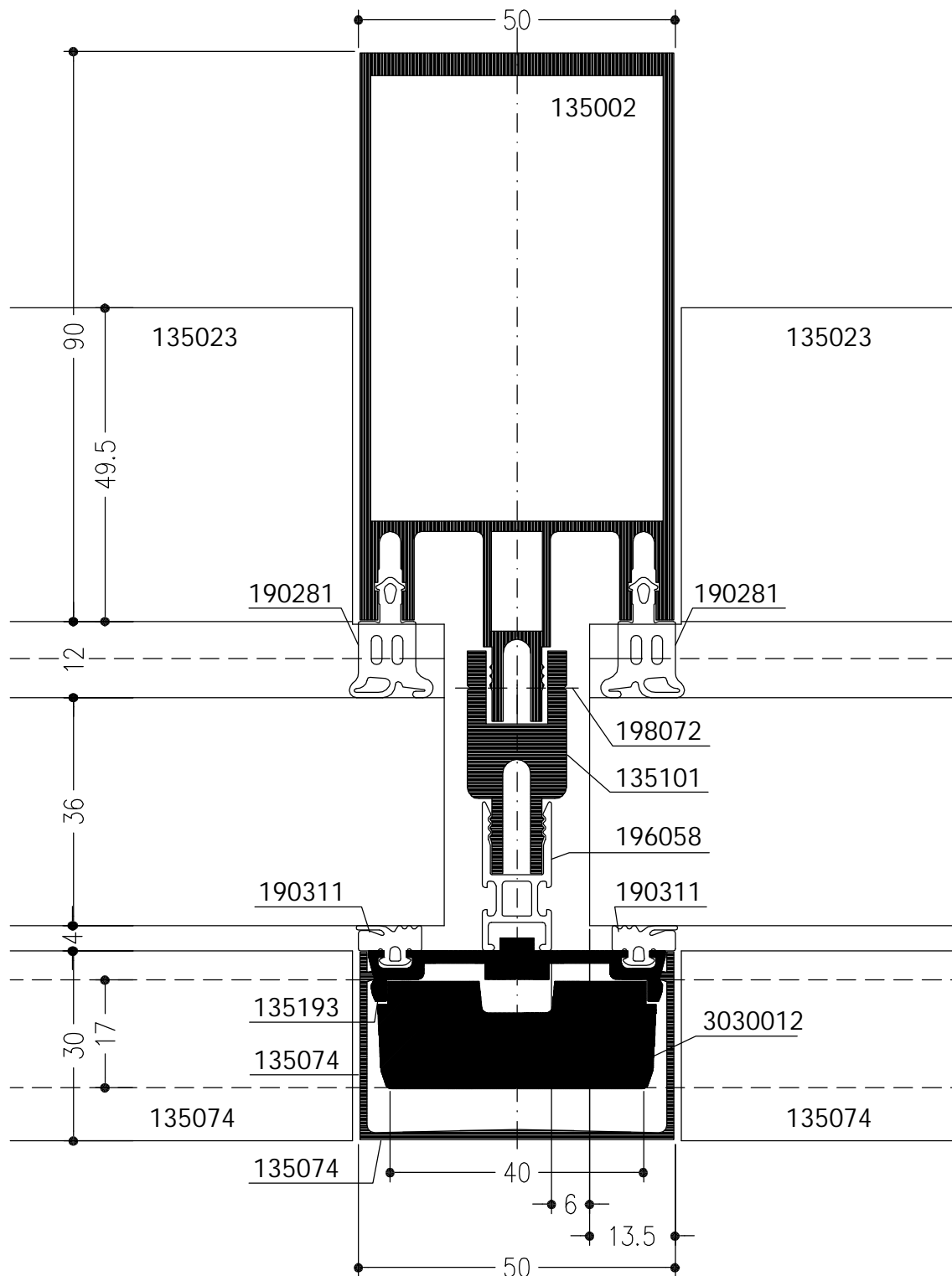
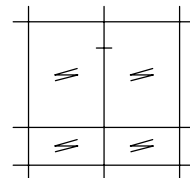

Horizontale doorsnede
stijl E1 met vaste beglazing BR4-S

WICTEC 50DH

Stijl-regel-gevel
Kogelwerend volgens DIN EN 1522
Weerstandsklasse FB4

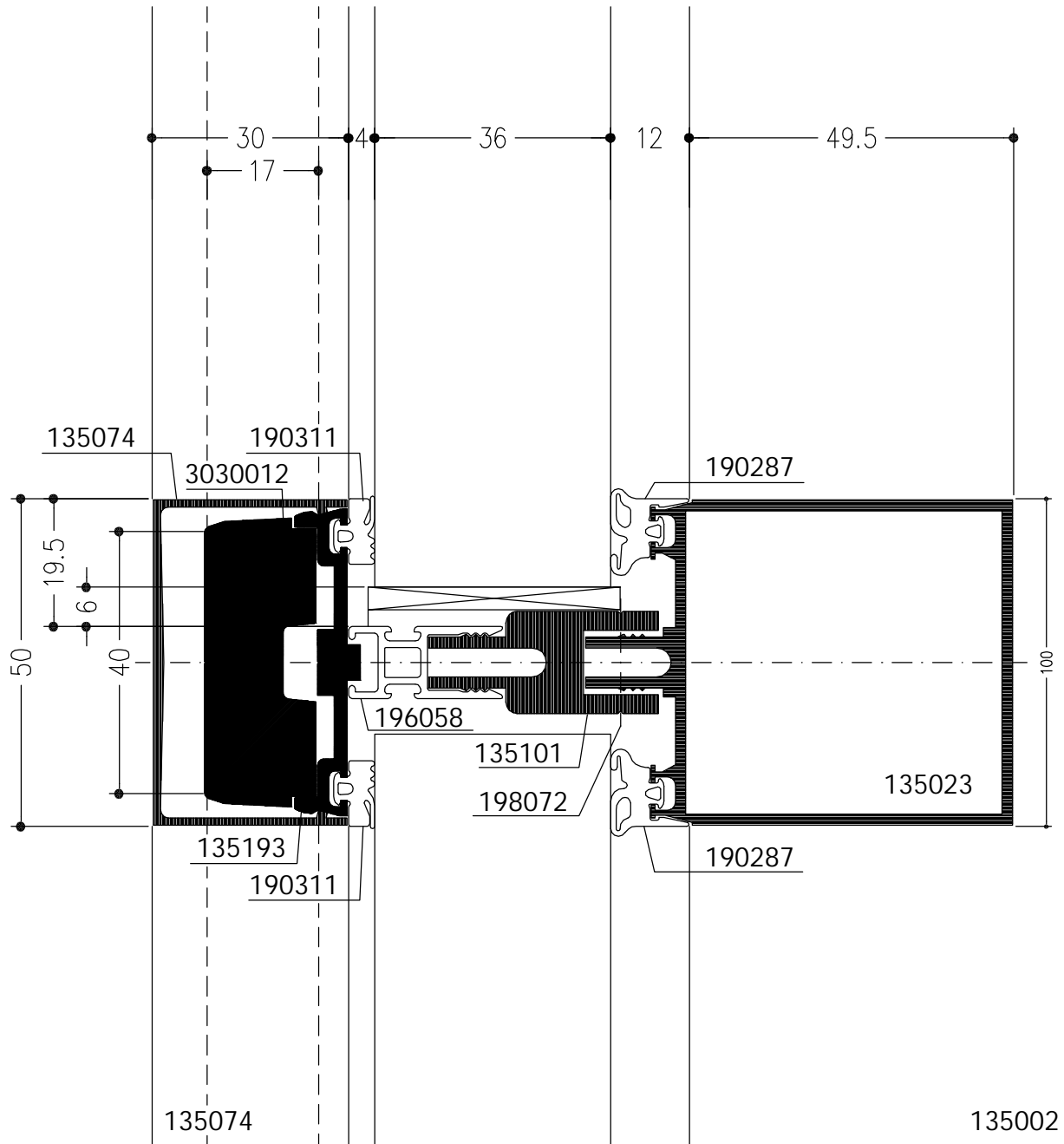
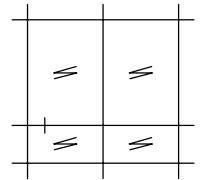

Verticale doorsnede
regel E2 met vaste beglazing BR4-S

WICTEC 50

Gordijn-regel-gevel
Kogelwerend volgens DIN EN 1522
Weerstandsklasse FB4

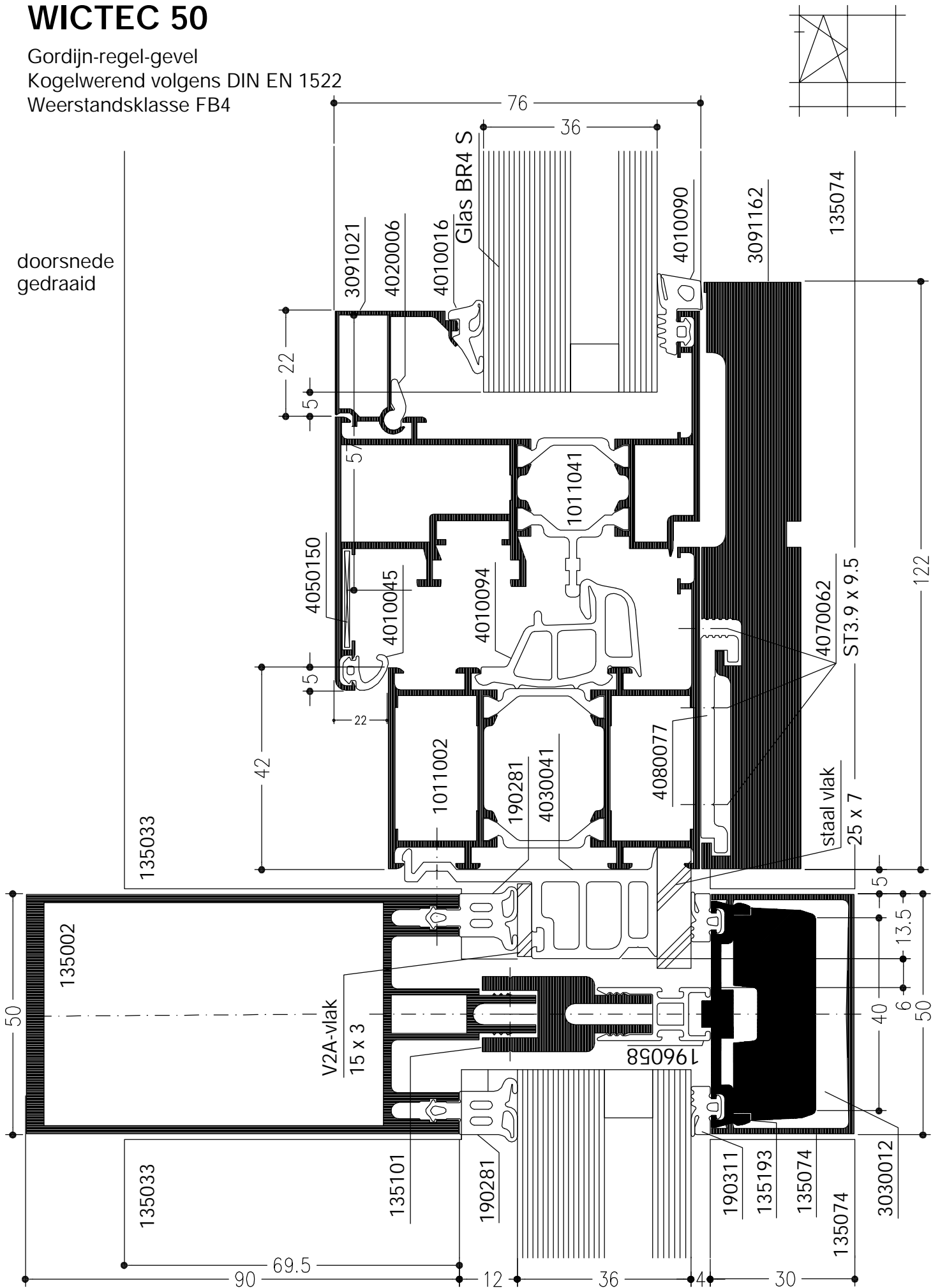

doorsnede
gedraaid

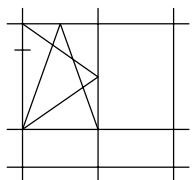

Horizontale doorsnede
stijl E1 met vleugel WICLINE 65

WICTEC 50DH

Stijl-regel-gevel
Kogelwerend
volgens DIN EN 1522
Weerstandsklasse FB4

doorsnede gedraaid

Horizontale doorsnede
stijl E1 met naar
buitendraaiende deur
WICSTYLE 65

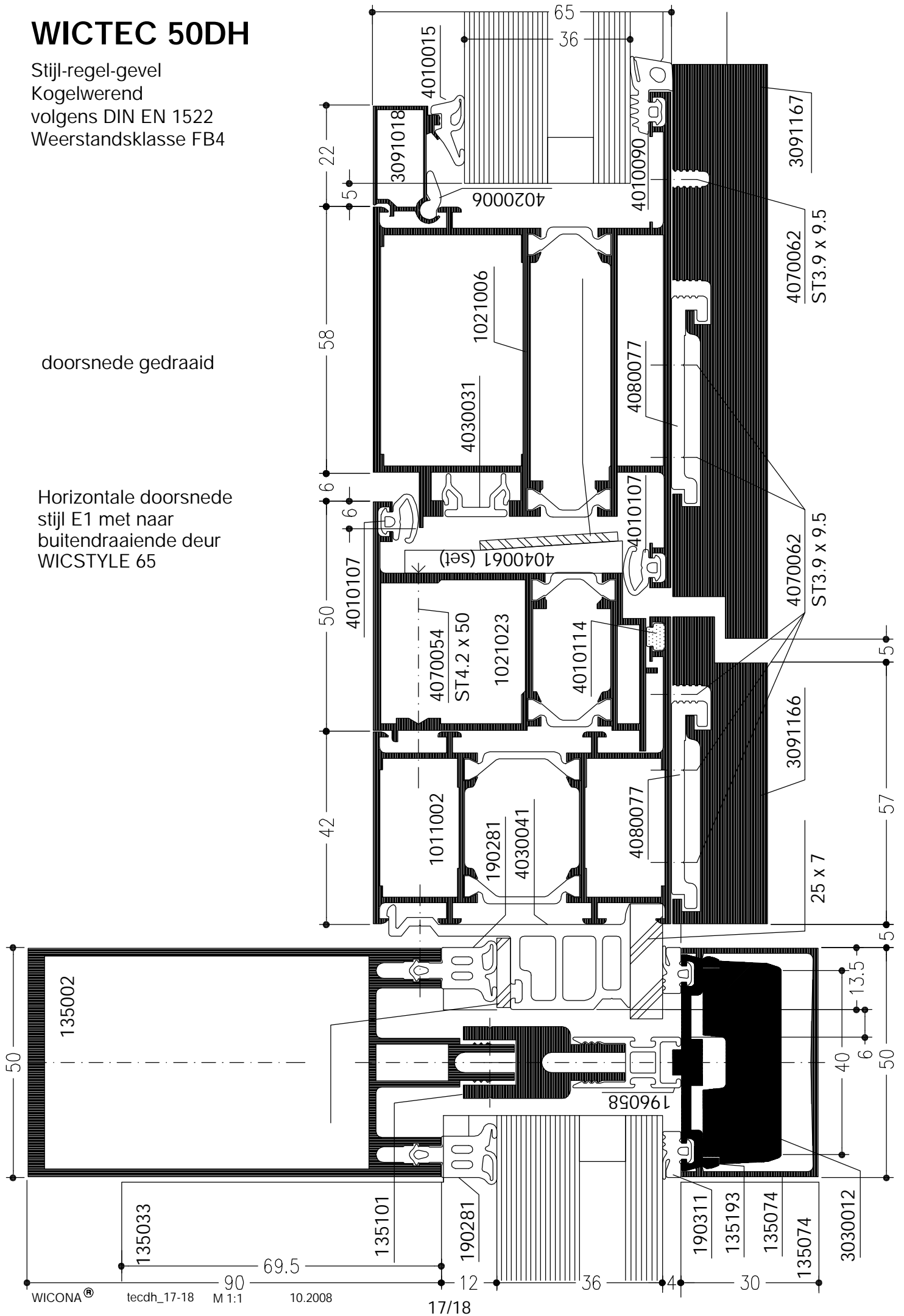

WICTEC 50DH

Stijl-regel-gevel
Kogelwerend volgens DIN EN 1522
Weerstandsklasse FB4

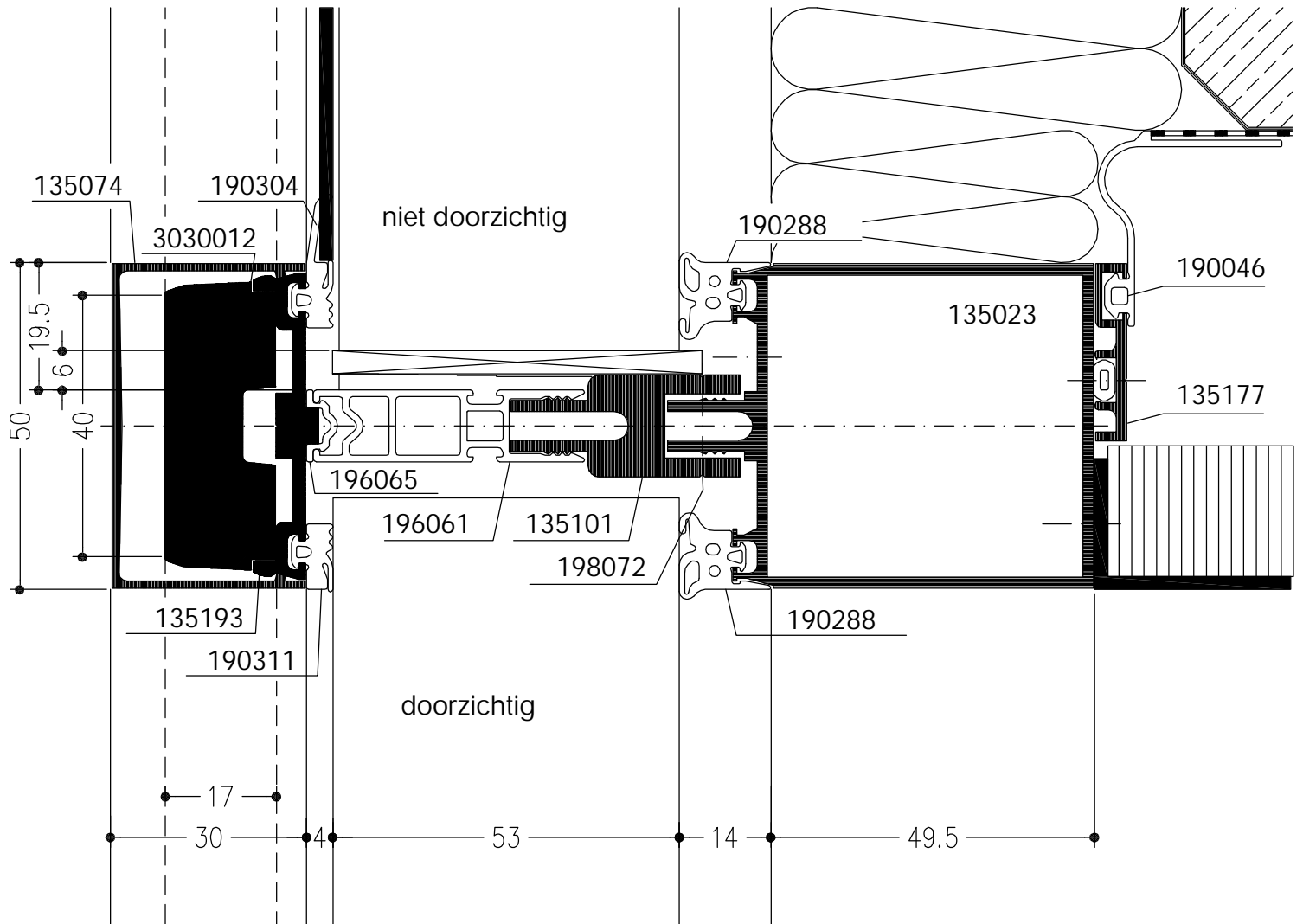
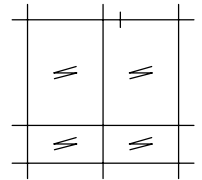

WICTEC 50DH

Stijl-regel-gevel
Kogelwerend
volgens DIN EN 1522
Weerstandsklasse FB4
doorsnede gedraaid

